

PRODUCT FEATURES

- Ultrafast Recovery Time
- Low Recovery Loss
- Soft Reverse Recovery Characteristics
- Low Leakage Current
- Low Forward Voltage
- High Surge Current Capability

APPLICATIONS

- Freewheeling, Snubber, Clamp
- Inversion Welder
- PFC
- Plating Power Supply
- Ultrasonic Cleaner and Welder
- Converter & Chopper
- UPS

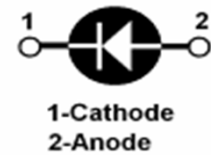
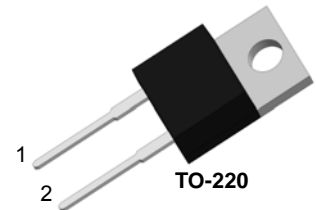

DESCRIPTION

FRED from MacMic utilizes advanced processing techniques to achieve ultrafast recovery times and higher forward current. Its soft recovery characteristics and high reliability suit for wide industrial applications.

ABSOLUTE MAXIMUM RATINGS

$T_C=25^{\circ}\text{C}$ unless otherwise specified

Symbol	Parameter/Test Conditions		Values	Unit
V_R	Maximum D.C. Reverse Voltage		700	V
V_{RRM}	Maximum Repetitive Reverse Voltage			
$I_{F(AV)}$	Average Forward Current	$T_C=110^{\circ}\text{C}$, Per Diode	8	A
$I_{F(RMS)}$	RMS Forward Current	$T_C=110^{\circ}\text{C}$, Per Diode	11	
I_{FSM}	Non-Repetitive Surge Forward Current	$T_J=45^{\circ}\text{C}$, $t=10\text{ms}$, 50Hz, Sine	100	
P_D	Power Dissipation		50	W
T_J	Junction Temperature		-55 to +150	$^{\circ}\text{C}$
T_{STG}	Storage Temperature Range		-55 to +150	$^{\circ}\text{C}$
Torque	Module-to-Sink	Recommended (M3)	1.1	N•m
$R_{th(J-C)}$	Junction-to-Case Thermal Resistance		2.5	$^{\circ}\text{C}/\text{W}$
Weight			2.5	g

ELECTRICAL CHARACTERISTICS

$T_C=25^{\circ}\text{C}$ unless otherwise specified

Symbol	Parameter/Test Conditions		Min.	Typ.	Max.	Unit
I_{RM}	Maximum Reverse Leakage Current				10	μA
					10	mA
V_F	Forward Voltage			1.3	1.6	V
				1.15		
trr	Reverse Recovery Time ($I_F = 1\text{A}$, $di_F/dt = -200\text{A}/\mu\text{s}$, $V_R = 30\text{V}$)			19		ns
trr	Reverse Recovery Time			130		ns
I_{RRM}	Maximum Reverse Recovery Current			3		
trr	Reverse Recovery Time			200		ns
I_{RRM}	Maximum Reverse Recovery Current			5.5		
S				4.5		

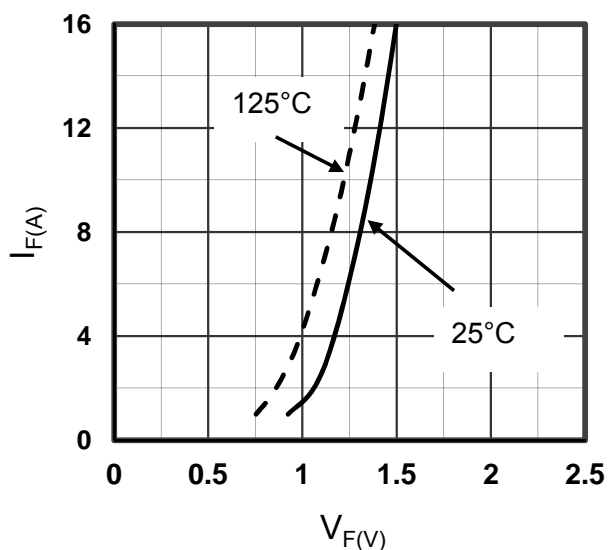

Figure1. Forward Voltage Drop vs Forward Current

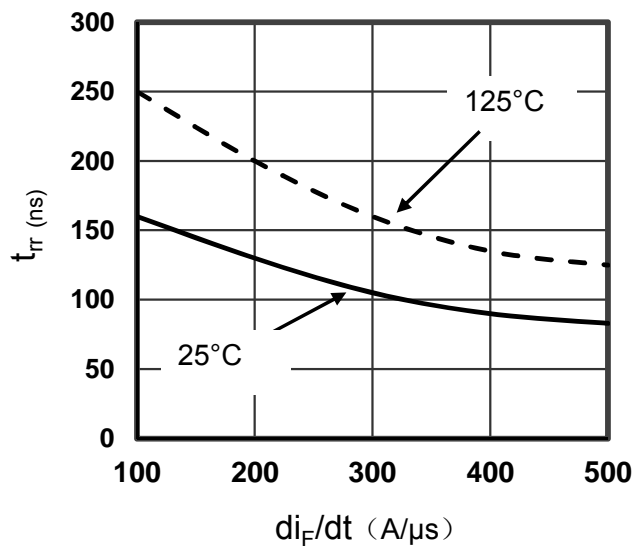

Figure2. Reverse Recovery Time vs diF/dt

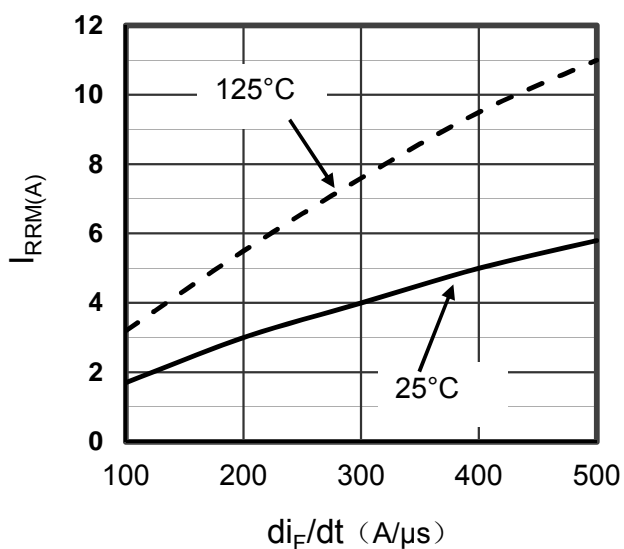

Figure3. Reverse Recovery Current vs diF/dt

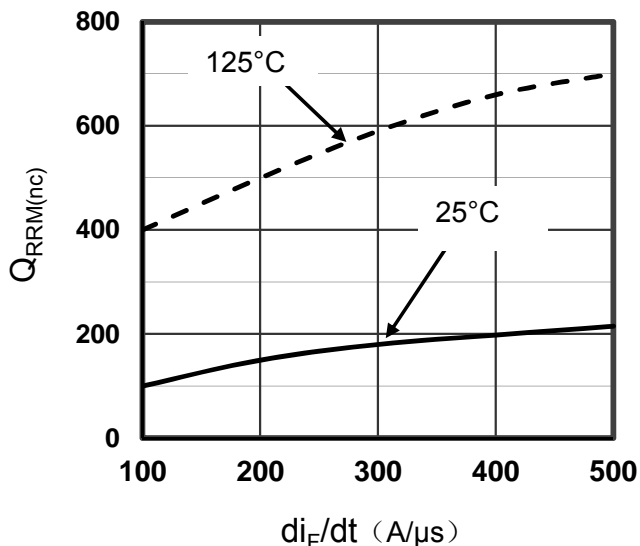

Figure4. Reverse Recovery Charge vs diF/dt

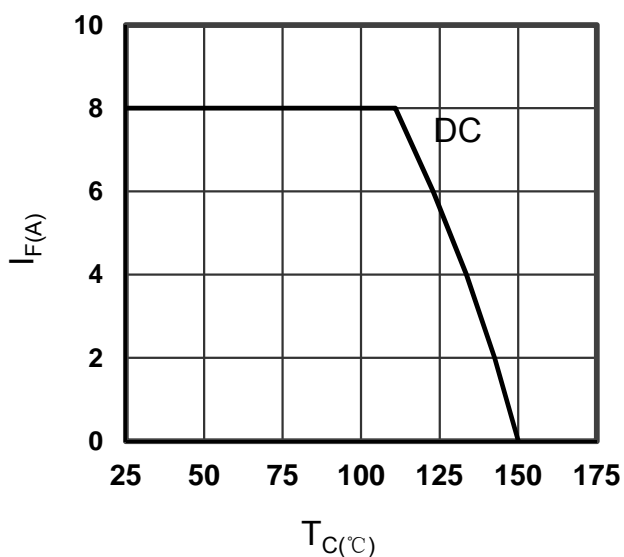

Figure5. Forward current vs Case temperature

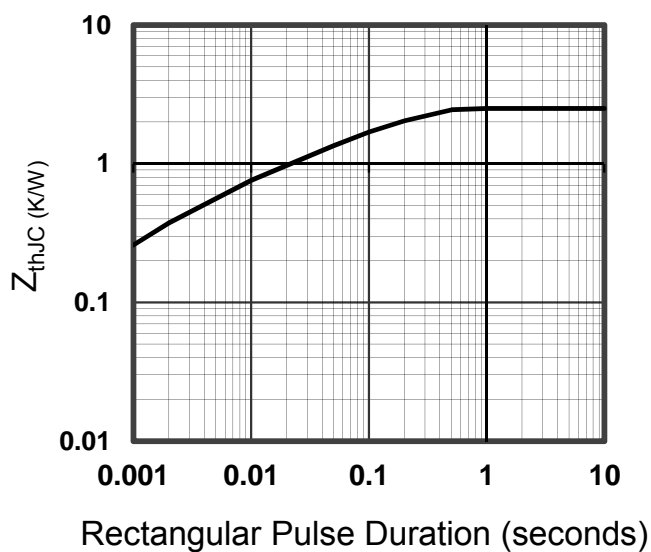

Figure6. Transient Thermal Impedance

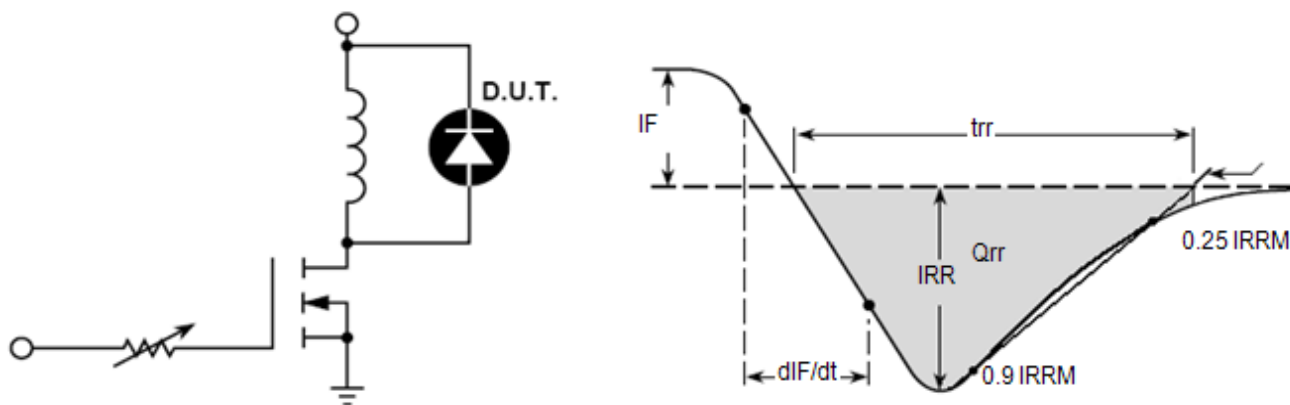
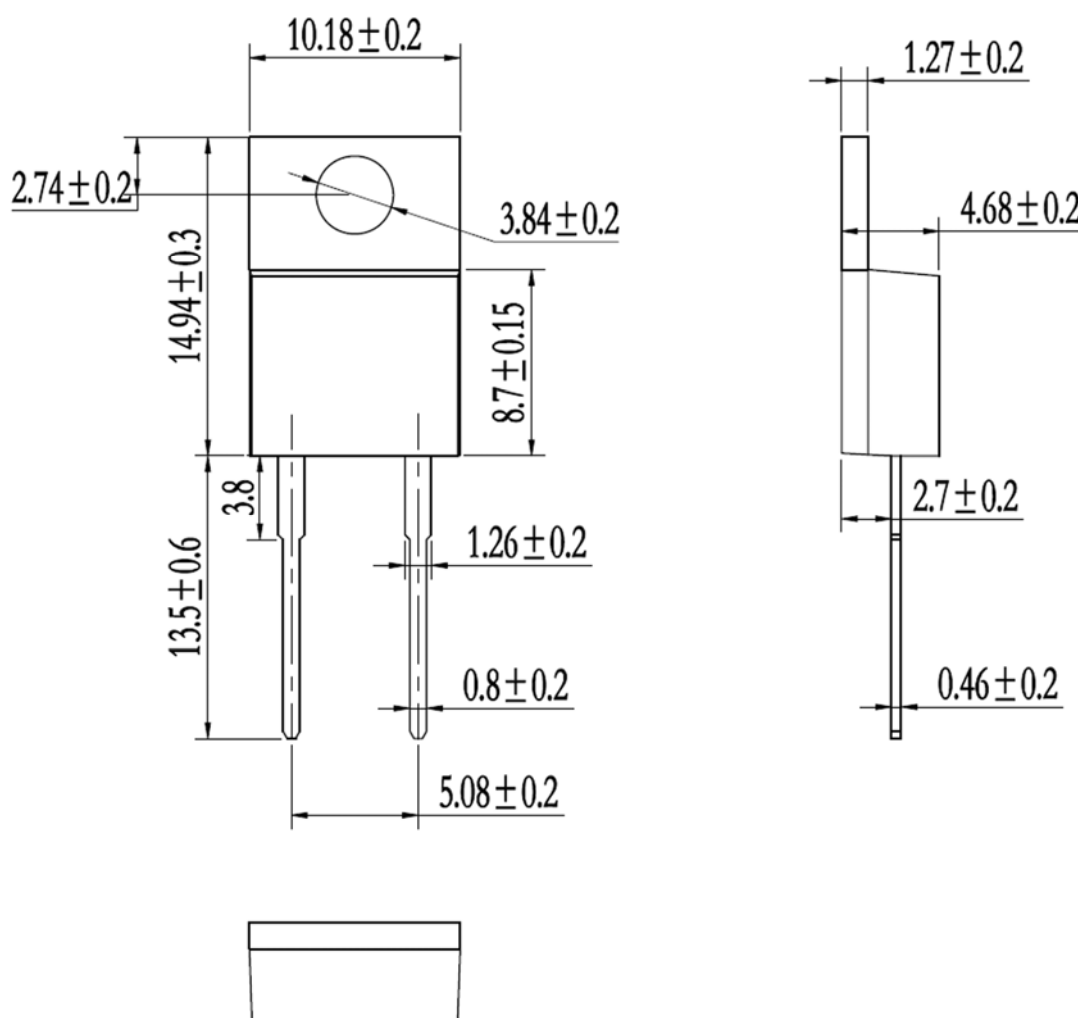

Figure7. Diode Reverse Recovery Test Circuit and Waveform



Dimensions in Millimeters
Figure8. Package Outline