

## PRODUCT FEATURES

- Ultrafast Recovery Time
- Soft Recovery Characteristics
- Low Recovery Loss
- Low Forward Voltage
- High Surge Current Capability
- Low Leakage Current

## APPLICATIONS

- Freewheeling, Snubber, Clamp
- Inversion Welder
- PFC
- Plating Power Supply
- Ultrasonic Cleaner and Welder
- Converter & Chopper
- UPS

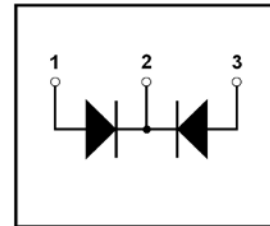
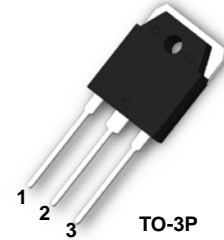

## DESCRIPTION

FRED from MacMic utilizes advanced processing techniques to achieve ultrafast recovery times and higher forward current. Its soft recovery characteristics and high reliability suit for wide industrial applications.

## ABSOLUTE MAXIMUM RATINGS

$T_C=25^{\circ}\text{C}$  unless otherwise specified

Symbol	Parameter	Test Conditions	Values	Unit
$V_R$	Maximum D.C. Reverse Voltage		400	V
$V_{RRM}$	Maximum Repetitive Reverse Voltage		400	V
$I_{F(AV)}$	Average Forward Current	$T_C=110^{\circ}\text{C}$ , Per Diode	40	A
		$T_C=110^{\circ}\text{C}$ , Per Package	80	A
$I_{F(RMS)}$	RMS Forward Current	$T_C=110^{\circ}\text{C}$ , Per Diode	56	A
$I_{FSM}$	Non-Repetitive Surge Forward Current	$T_J=45^{\circ}\text{C}$ , $t=10\text{ms}$ , 50Hz, Sine	400	A
$P_D$	Power Dissipation		156	W
$T_J$	Junction Temperature		-40 to +150	$^{\circ}\text{C}$
$T_{STG}$	Storage Temperature Range		-40 to +150	$^{\circ}\text{C}$
Torque	Module-to-Sink	Recommended (M3)	1.1	N-m
$R_{\theta JC}$	Thermal Resistance	Junction-to-Case	0.8	$^{\circ}\text{C}/\text{W}$
Weight			6.0	g

## ELECTRICAL CHARACTERISTICS

$T_C=25^{\circ}\text{C}$  unless otherwise specified

Symbol	Parameter	Test Conditions	Min.	Typ.	Max.	Unit
$I_{RM}$	Reverse Leakage Current	$V_R=400\text{V}$	--	--	10	$\mu\text{A}$
		$V_R=400\text{V}$ , $T_J=125^{\circ}\text{C}$	--	--	150	$\mu\text{A}$
$V_F$	Forward Voltage	$I_F=40\text{A}$	--	1.3	1.8	V
		$I_F=40\text{A}$ , $T_J=125^{\circ}\text{C}$	--	1.1		V
$t_{rr}$	Reverse Recovery Time	$I_F=1\text{A}$ , $V_R=30\text{V}$ , $di_F/dt=-200\text{A}/\mu\text{s}$	--	22	--	ns
$t_{rr}$	Reverse Recovery Time	$V_R=200\text{V}$ , $I_F=40\text{A}$	--	52	--	ns
$I_{RRM}$	Max. Reverse Recovery Current	$di_F/dt=-200\text{A}/\mu\text{s}$ , $T_J=25^{\circ}\text{C}$	--	4.5	--	A
$t_{rr}$	Reverse Recovery Time	$V_R=200\text{V}$ , $I_F=40\text{A}$	--	71	--	ns
$I_{RRM}$	Max. Reverse Recovery Current	$di_F/dt=-200\text{A}/\mu\text{s}$ , $T_J=125^{\circ}\text{C}$	--	9	--	A

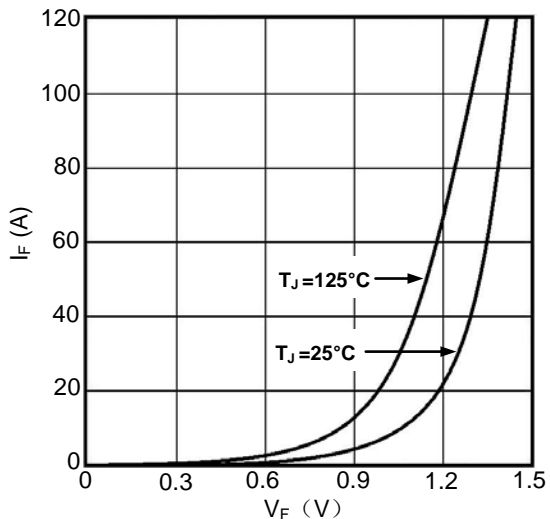

Fig1. Forward Voltage Drop vs Forward Current

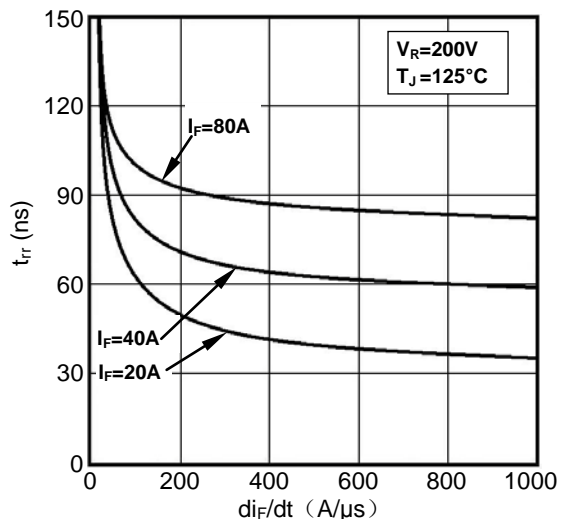

Fig2. Reverse Recovery Time vs  $di_F/dt$

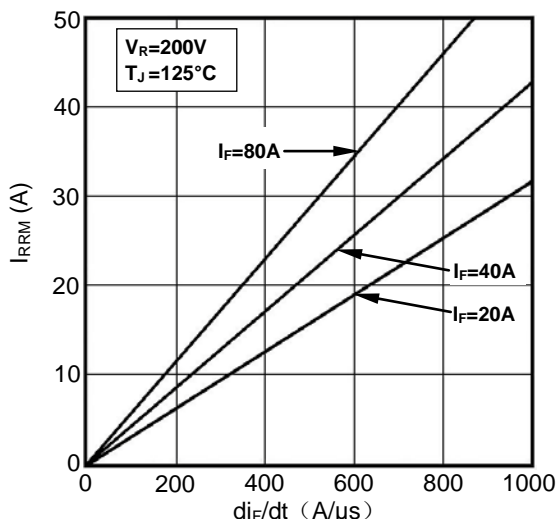

Fig3. Reverse Recovery Current vs  $di_F/dt$

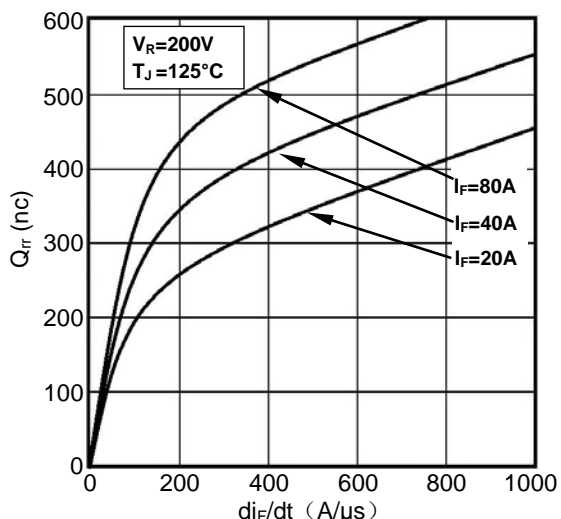

Fig4. Reverse Recovery Charge vs  $di_F/dt$

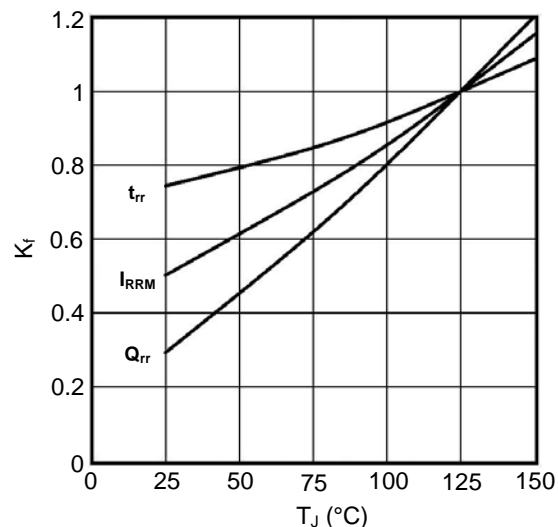

Fig5. Dynamic Parameters vs Junction Temperature

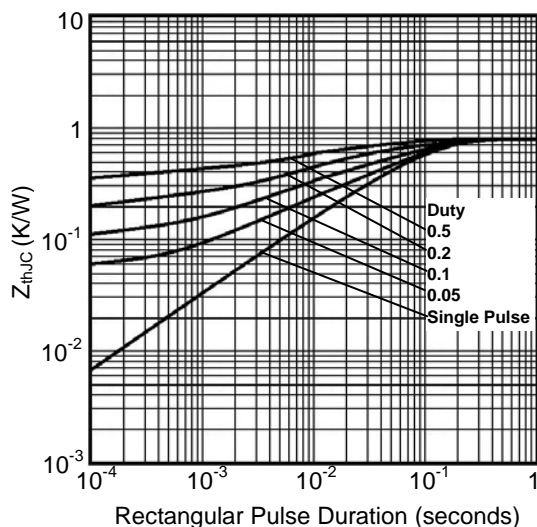

Fig6. Transient Thermal Impedance

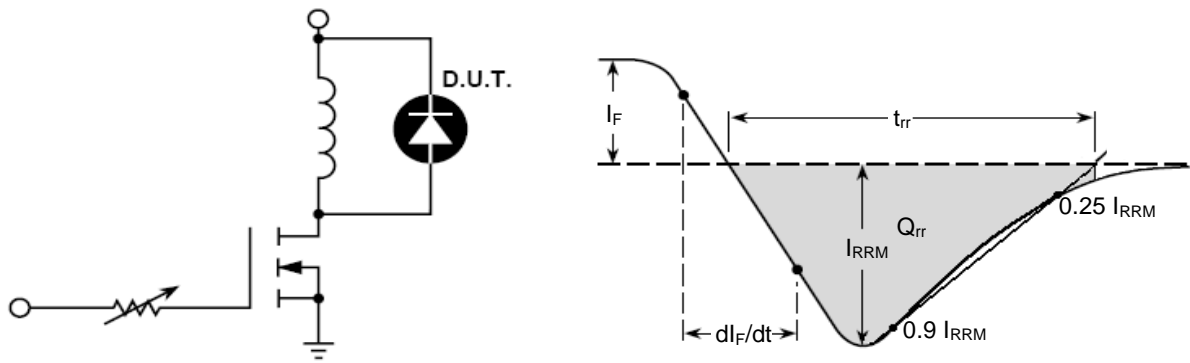
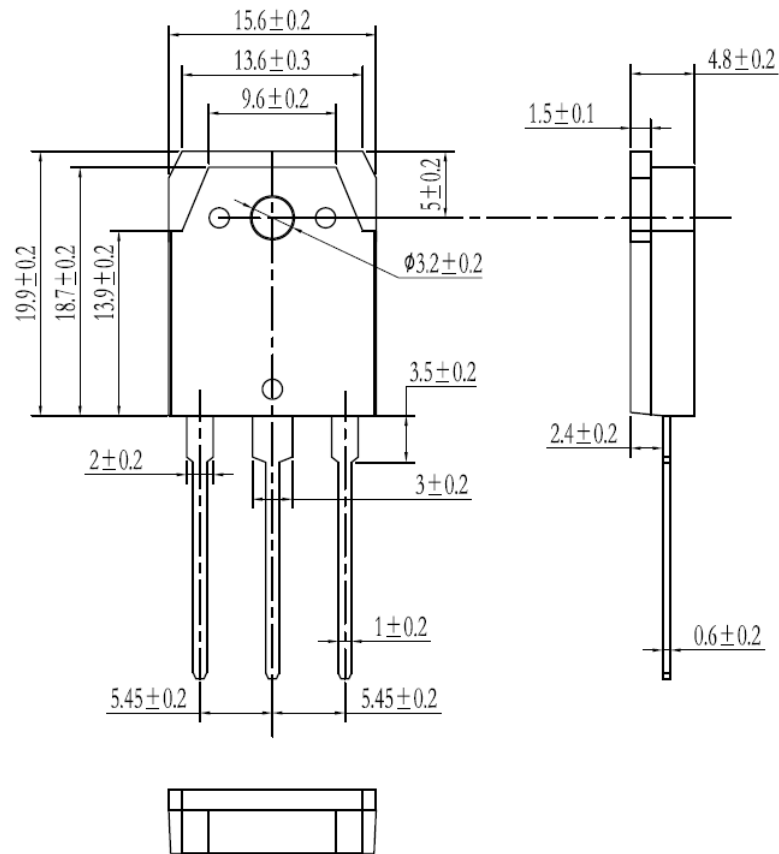

Fig7. Diode Reverse Recovery Test Circuit and Waveform



Dimensions in Millimeters  
Fig8. Package Outline